



Sunflower Warmer

Radiant Warmer



Simple and Versatile

Total support from postnatal treatment to NICU care.
The most suitable model can be chosen from a cost-effective line up.

Hi-Low/Tilt



Cabinet/Tilt



Stand



Wall Mount



Sufficient optional accessories to neonatal care can be mounted.

Surgical operations can be performed safely in the NICU.

◆ Wide accessible workspace for surgical treatment

- Easy to handle the anesthetic equipment.
- A range of peripheral devices such as resuscitation unit (T-piece resuscitator, oxygen blender and suction unit), phototherapy unit, examination light, weight monitor, syringe pump, etc. can be mounted through F-Rail.

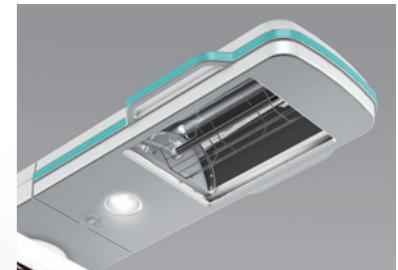

• LED light helps the medical staff to observe the infant.

“Baby-friendly” function to relieve infant’s stress.

◆ Reduces the infant’s stress and supports daily care giving

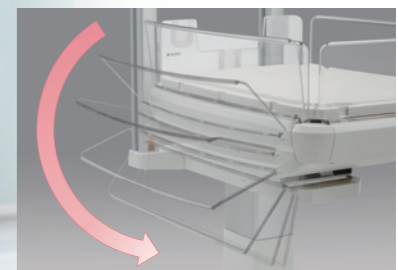

• Baby-guard with very quiet rotary damper.

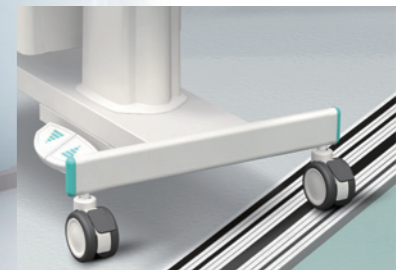

• Double-wheel caster enables stable and smooth transportation.

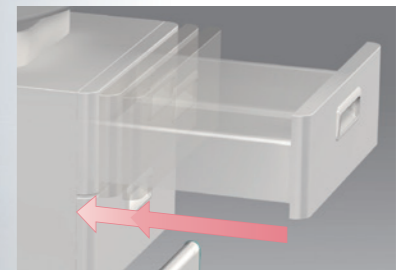

• Self closing doors that close slowly and silently.
*The drawer shown is optional.



Hi-Low/Tilt
* The drawer shown is optional

Best for urgent postnatal treatment.

Prompt and safe resuscitation can be performed.

◆ **Resuscitation treatment in compliance with ILCOR Consensus 2015 can be achieved.**

• CPR Timer prompts the user to assess the health condition of the infant every 30 seconds.

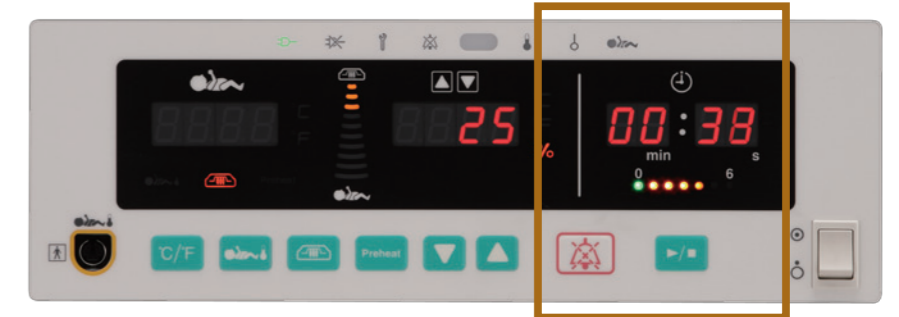

• Resuscitation unit (T-piece resuscitator, oxygen blender and suction unit) and weight monitor, etc. can be mounted to F-Rail.

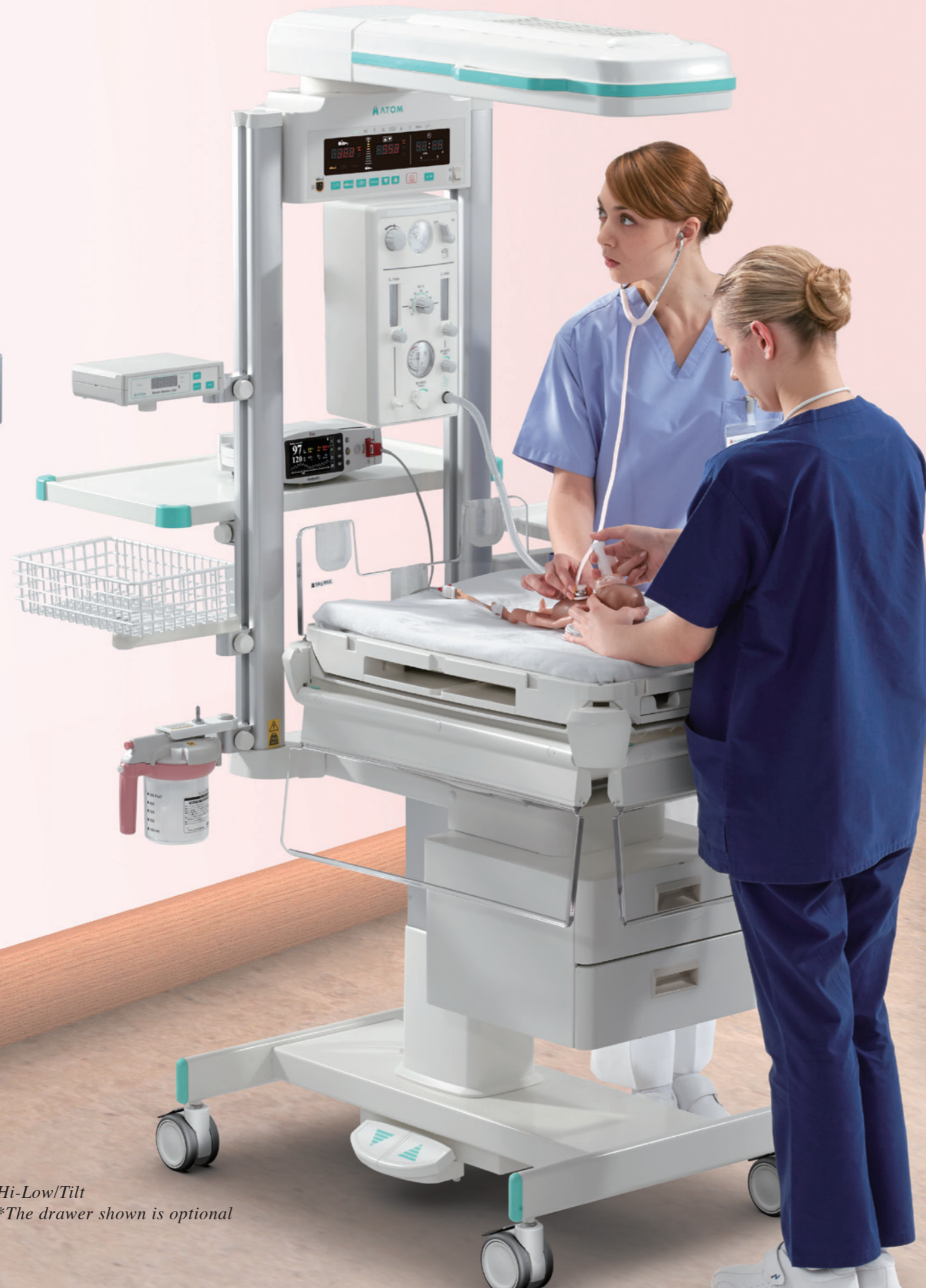

Hi-Low/Tilt
*The drawer shown is optional

Utility design.

*Sunflower Warmer
Hi-Low/Tilt*



HL Stand	✓
Fixed Stand	—
Apgar Timer	✓
CPR Timer	✓
Mattress platform tilting	✓
Rotary damper	✓
Drawer	▲
Cabinet	—
Double-wheel Caster	✓
Single-wheel Caster	—
X-Ray cassette tray port	✓
Examination light	✓

✓: Included as standard
—: Not available ▲: Optional

Maneuverable design.

*Sunflower Warmer
Stand*



HL Stand	—
Fixed Stand	✓
Apgar Timer	✓
CPR Timer	✓
Mattress platform tilting	—
Rotary damper	—
Drawer	—
Cabinet	—
Double-wheel Caster	—
Single-wheel Caster	✓
X-Ray cassette tray port	—
Examination light*	✓

✓: Included as standard —: Not available
* Except for US

*Sunflower Warmer
Cabinet/Tilt*



HL Stand	—
Fixed Stand	✓
Apgar Timer	✓
CPR Timer	✓
Mattress platform tilting	✓
Rotary damper	✓
Drawer	—
Cabinet	✓
Double-wheel Caster	✓
Single-wheel Caster	—
X-Ray cassette tray port	✓
Examination light	✓

✓: Included as standard —: Not available

Space-saving design.

*Sunflower Warmer
Wall Mount*



HL Stand	—
Fixed Stand	—
Apgar Timer	✓
CPR Timer	✓
Mattress platform tilting	—
Rotary damper	—
Drawer	—
Cabinet	—
Double-wheel Caster	—
Single-wheel Caster	—
X-Ray cassette tray port	—
Examination light*	✓

✓: Included as standard —: Not available
* Except for US





Atom's code. 60983
Drawer, 2 Layers
For Infa Warmer i/
Sunflower Warmer

Hi-Low/Tilt Cabinet/Tilt Stand
Wall Mount

Self-closing drawer that closes slowly and silently.



Atom's code. 60899
Handle
For F-Rail

Hi-Low/Tilt Cabinet/Tilt Stand
Wall Mount

The vertical position of the handle can be adjusted easily according to the height of the operator. It is conveniently used to move Sunflower Warmer to another place.

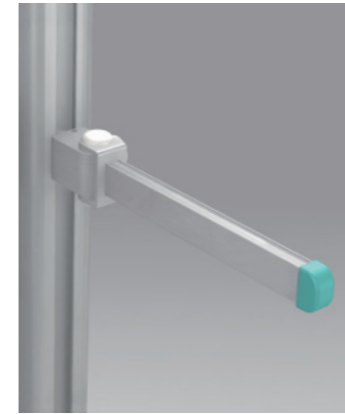

Atom's code. 61616
MF-Rail
For F-Rail
(Common to Left & Right)

Hi-Low/Tilt Cabinet/Tilt Stand
Wall Mount

This rail is used to mount the peripheral devices attachable to the MF-Rail for F-Rail.

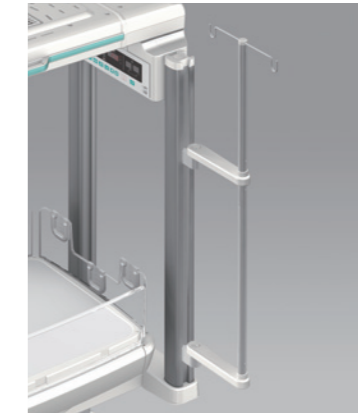

Atom's code. 60893
I.V. Pole
For F-Rail

Hi-Low/Tilt Cabinet/Tilt Stand
Wall Mount

With the load capacity of 10kg, this I.V. Pole can mount the weight of various peripheral devices.

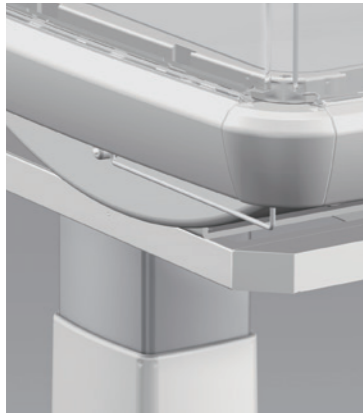

Atom's code. 61642
Drainage Hanger
For Infa Warmer i/
Sunflower Warmer

Hi-Low/Tilt Cabinet/Tilt Stand
Wall Mount

The Drainage Hanger is used to hang a low-pressure continuous aspirator and drainage bag on Sunflower Warmer.



Atom's code. 60871
Tube Holder
For Infa Warmer i/
Sunflower Warmer /V-505

Hi-Low/Tilt Cabinet/Tilt Stand
Wall Mount

The Tube Holder is attached to the baby guard at the head end of the warmer to hold the patient circuit securely in place.

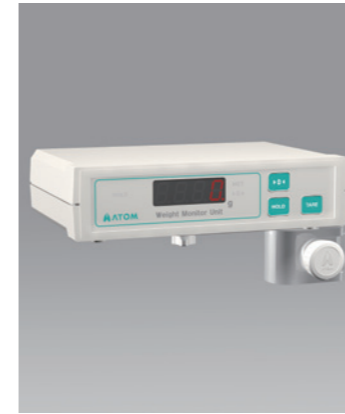

Atom's code. 61647/61640
(for USA only)
Weight Monitor Unit
For Infa Warmer i/
Sunflower Warmer

Hi-Low/Tilt Cabinet/Tilt Stand
Wall Mount

You can weigh a baby placed on the mattress platform whenever necessary.



Atom's code. 60216
InfaLite

Hi-Low/Tilt Cabinet/Tilt Stand
Wall Mount

With a LED light and hands-free motion sensor, both brightness and hygiene have been considered with this examination light.

*Either F-Rail attachment or Pole attachment is required for the installation of InfaLite.



Atom's code. 60984
Shelf
For Sunflower Warmer

Hi-Low/Tilt Cabinet/Tilt Stand
Wall Mount

Shelf with wide space can place a SpO2 monitor, etc.



Atom's code. 61618
Tray Set (S)
For F-Rail

Hi-Low/Tilt Cabinet/Tilt Stand
Wall Mount

The vertical position of the Tray Set (S) can be adjusted easily according to the height of the operator. Small instruments necessary for routine medical procedures can be placed on this small tray.



Atom's code. 60362
Resusci Flow

Hi-Low/Tilt Cabinet/Tilt Stand
Wall Mount

"Resusci Flow" is a resuscitation unit that performs artificial respiration with a stable pressure.

- Simple operation supports resuscitation.
- Safety function to protect newborn's respiration.
- Supports artificial respiration in various situations.



Atom's code. 60894
Basket
w/arm For F-Rail

Hi-Low/Tilt Cabinet/Tilt Stand
Wall Mount

The vertical position of the basket can be adjusted easily as desired. The basket is deep enough to conveniently accommodate tall containers such as bottles of alcohol disinfectant solutions.



Atom's code. 60350
Monitor Table for Philips monitor
For F-Rail

Hi-Low/Tilt Cabinet/Tilt Stand
Wall Mount

Philips monitor can be mounted on the monitor table.



Atom's code. 60361
BILI-THERAPY Spot Type Arm Type

Hi-Low/Tilt Cabinet/Tilt Stand
Wall Mount

Effective Phototherapy Treatment and Space-saving

- Effective phototherapy treatment by blue LEDs
Promote early hospital discharge by reducing the treatment time in providing high irradiation intensity and effective wavelength.
- Space-saving
The unit can be mounted on the F-Rail without using a stand for space-saving around the incubator or warmer.
- Switchable to examination lamp with one-touch of a button
The condition of an infant can be monitored by the examination lamp (White LEDs).
The dimmer function ideal for developmental care is available.

Products Lineup

Sunflower Warmer

Type	Atom's code	Description
Hi-Low/Tilt	61564	AC120V±10%
	61565	AC230V±10%
Cabinet/Tilt	61566	AC120V±10%
	61567	AC230V±10%

Type	Atom's code	Description
Stand	61572	AC120V±10%
	61573	AC230V±10%
Wall Mount	61574	AC120V±10%
	61575	AC230V±10%

Specifications

Power requirements	Customer specified	
Power consumption	Main Unit : 700VA HL Stand : 120VA	
Frequesncy	50/60Hz	
Type of protection	Class I	
Degree of protection	Type BF applied part	
Classification	IIb, Rule 9	
Heater capacity	500W	
Dimensions	HL/Tilt : 640(W)x1140(D)x1770~1970(H) mm Cabinet/Tilt : 610(W)x1060(D)x1870(H) mm Stand : 730(W)x950(D)x1840(H) mm Wall mount : 450(W)x950(D)x300(H) mm	
Mattress surface	HL/Tilt	800~1000 mm
	Cabinet/Tilt	900 mm
	Stand	660~860 mm
	Wall mount	Depends on mount height
Weight	HL/Tilt	Approx. 89Kg
	Cabinet/Tilt	Approx. 96Kg
	Stand	Approx. 51Kg
	Wall mount	Approx. 20Kg

Accessories	HL/Tilt	Skin temp. probe x 1, Dust cover x 1, Cord holder x 2, Operation Manual x 1
	Cabinet/Tilt	Skin temp. probe x 1, Dust cover x 1, Cord holder x 2, Operation Manual x 1
	Stand	Skin temp. probe x 1, Cord holder x 2, Operation Manual x 1
	Wall mount	Skin temp. probe x 1, Operation Manual x 1
Heater output setting range	0~100% (in 5% increments)	
Heater output indication	In 10 levels	
Skin temp. setting range	34.0~38.0°C / 93.2~100.4°F (in 0.1°C/°F increments)	
Skin temp. display range	30.0~42.0°C / 86.0~107.6°F (in 0.1°C/°F increments)	
Skin temp. display accuracy	±0.3°C / ±0.5°F	
Timer	0~60 minutes 00 second (in one second increments) Apger mode / CPR mode selectable	
Mattress platform tilting	Longitudinal tilt of ±13°(freely adjustable)	
Canopy mobility range	Horizontal rotation : 170°(85°both sides)	
Lighting	600Lx	
Preheat	Available	
Alarms	Set temp., Baby check, Power failure, System failure, Skin temp. probe	

Dimensional drawing Unit:mm

■ Hi-Low/Tilt

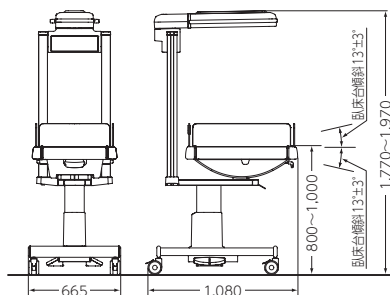

■ Cabinet/Tilt

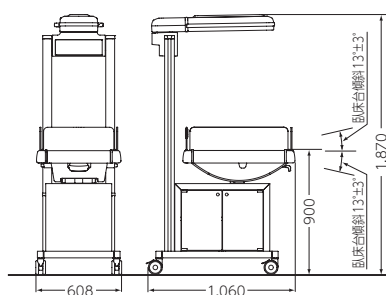

■ Stand

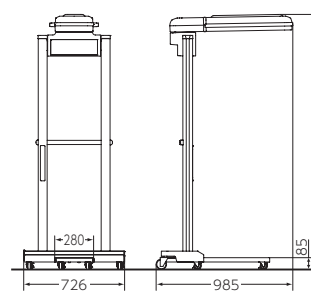

■ Wall Mount

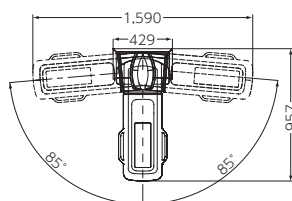
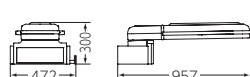

Atom Medical products are produced under strict production control in Japan.
We provide value and trust of the highest quality for the tiny baby lives in the world.

Manufacturer: ATOM MEDICAL CORPORATION

18-15, Hongo 3-chome, Bunkyo-ku, Tokyo, 113-0033 JAPAN
<https://www.atomed.co.jp>

Exporter: ATOM MEDICAL INTERNATIONAL, INC.

SWT Bldg., 15-9 Hongo 3-chome, Bunkyo-ku, Tokyo, 113-0033 JAPAN
Phone: + 81 3 3815 2941 Fax: + 81 3 3812 9670/4080